

Product Specification Sheet

ACT2S14PS-A2

Line Voltage: 220~240Vac 50/60Hz
 Safety Voltage: 187~264Vac 50/60Hz
 EEI=A2
 High Power Factor
 Operating Frequency: 40~50kHz
 Preheat Starting

Auto Reset after Lamp Replacement
 RoHS Compliance
 Abnormal Protection
 U-out=280V
 Tc(max): 65°C
 Ta(max): 50°C

Lamp Type	Qty of Lamps	Mini. Start Temp (°C)	Input Current (A)	Input Wattage (W)	Power Factor	ATHD (%)	CF	Ballast Factor
T5 14W	2	-10@198V	0.15	33	0.98	20	1.7	1.0

Application and Performance Specification Information Subject to Change Without Notification

Standards

IEC61347-1
 IEC61347-2-3
 IEC61000-3-2
 EN55015 (CISPR15)
 EN61547

Safety

No PCB's
 CE
 Sound Rated: A

Physical Parameters

Overall Length (L): 290 ± 1 mm
 Width (W): 29.8 ± 1mm
 Height (H): 20 ± 1mm
 Mounting Length (L'): 274 ± 1mm
 Weight: 152g

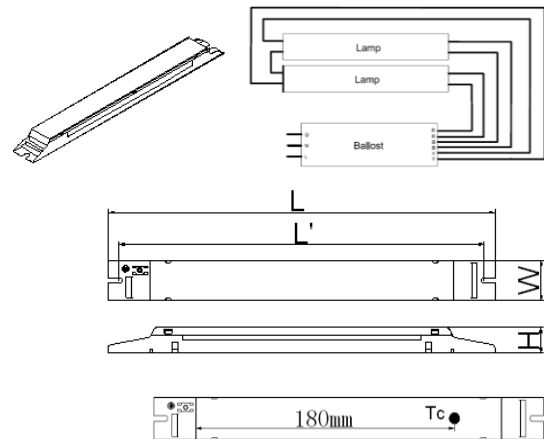

Caution

Install in accordance with the national electrical code; Disconnect power before serving; Use single solid copper wire (cross section area is 0.5~1.0mm², stripped to 7.5~8.5mm) to connect ballast and lamp.

Warranty:

Arcata electronics Inc warrants that each electronic ballast will be free from defects in material or workmanship including replacement for 3 years from the date of manufacture when properly installed and under normal condition use.